



Burris



USER MANUAL

FASTFIRE™ C

FASTFIRE™ C RED DOT REFLEX SIGHT

Congratulations on purchasing the Burris® FastFire™ C! This versatile red dot reflex sight is the perfect fast-action sighting solution for your concealed carry and slim handguns. You will enjoy the following features in your FastFire C sight:

- **COMPACT & LIGHTWEIGHT.** Weighing less than 1 ounce, the FastFire C won't affect firearm balance or handling. The frame is built from advanced composite polymers for ultimate reliability and recoil resistance.
- **1X MAGNIFICATION.** The parallax-free, FastFire C allows for both-eyes-open shooting, for enhanced awareness and better accuracy.
- **BRIGHT RED 6 MOA AIMING DOT** Allows for fast target acquisition and easy aiming.
- **BURRIS INTELLIGENT AUTOBRIGHT** keeps the optic always on and ready for anything no matter the lighting conditions.
- **WINDAGE & ELEVATION ADJUSTMENTS.** Fine-tune your point-of-aim with no special tools required.



WATER RESISTANT



SHOCKPROOF



FOGPROOF

TABLE OF CONTENTS	
SPECIFICATIONS	4
PACKAGE CONTENTS	
OPERATING INSTRUCTIONS	5
CAUTIONS & WARNINGS	
KEY FEATURES	
BURRIS INTELLIGENT AUTO BRIGHT	
BATTERY INSTALLATION	
MOUNTING	
INSTALLING AND REMOVING REAR POST SIGHT	6
OPERATING PROCEDURES	8
POWER MODES	
BURRIS INTELLIGENT AUTO BRIGHT	
ELEVATION & WINDSAGE ADJUSTMENT	
ZEROING POINT OF IMPACT	9
WARRANTY	10
CARE AND MAINTENANCE	
BURRIS CONNECT	11

SPECIFICATIONS

- **MAGNIFICATION:** 1x
- **SIGHT WINDOW:** 22mm x 17mm (0.87" x 0.67")
- **RETICLE:** 6 MOA
- **ELEVATION ADJUSTMENT RANGE:** 80 MOA
- **WINDAGE ADJUSTMENT RANGE:** 80 MOA
- **ADJUSTMENT GRADUATION (MOA PER TICK MARK):** 4 MOA
- **OPERATING TEMPERATURE RANGE:** -4°F to +140°F (-20°C to +60°C)
- **STORAGE TEMPERATURE RANGE:** -22°F to +140°F (-30°C to +60°C)
- **POWER SUPPLY:** One CR2032 Lithium battery
- **DIMENSIONS: (LXWXH)** 1.61" x 0.99" x 0.98" (40.8mm x 25.1mm x 24.9mm)
- **WEIGHT (IN OPERATING CONDITION WITHOUT MOUNTING MATERIALS):** 0.44 oz. (12.5 grams)
- **DEFAULT TO AUTOBRIGHTNESS:** 5 hours
- **BATTERY LIFE:** 25,000 hours on Medium

PACKAGE CONTENTS

- FastFire C
- Removable Rear Post Sight
- 60 MOA (1°) shim
- (4x) M4x0.7 6.5mm Screws
- (4x) M4x0.7 7.0mm Screws
- (4x) M3x0.5 7.5mm Screws
- (4x) 6-32 8.2mm Screws
- Sight Adjustment / Mounting Tool
- 1 Lithium Battery (CR2032)
- Lens Cleaning Cloth
- User Guide

OPERATING INSTRUCTIONS

For optimum performance and to prevent damage to this precision instrument, carefully follow all instructions.

CAUTIONS AND WARNINGS

Use proper firearms safety. Make sure the firearm is unloaded before mounting the optic.

KEY FEATURE:

BURRIS INTELLIGENT AUTO BRIGHT

The integrated control circuit adjusts the brightness of the aiming dot according to surrounding light levels. The brightness sensor detects the light level in the direction of the target and modifies the intensity of the dot accordingly so that it is not overpowering in low light while remaining highly visible in bright daylight. When holstered, or stored, the optic goes into an ultra-low brightness setting, saving the battery for when you need it! Bringing your firearm up to ready, instantly brings the dot back to the optimal level! Be careful not to obstruct the sensor. Clean if necessary. If you wish to check its function, cover the sensor.

BATTERY INSTALLATION

The FastFire C operates with one Lithium CR2032 battery.

The battery is installed on the bottom of the optic with the positive (+) side facing down and must be installed with the optic removed from firearm. The battery is secured into place when the optic is mounted. Screws should be torqued to 9in-lbs.

FIGURE 1

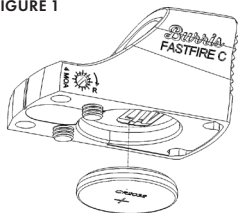

MOUNTING

The FastFire C features a **Shield RMSc™** footprint designed specifically for popular full size and compact handguns. To mount the optic, first make sure your firearm has the appropriate mounting footprint. If it does not, we recommend sourcing a 3rd party adapter plate. Additionally, your firearm will need to accept one of the four sets of mounting screws provided. Refer to your firearm user manual for more information about screw sizes.

INCLUDED SCREW SIZES

(4x) M4x0.7 6.5mm

(4x) M4x0.7 7.0mm

(4x) M3x0.5 7.5mm

(4x) 6-32 8.2mm

To mount the optic, line it up with the mounting holes on your slide, insert the appropriate screws recommended by your firearm manufacturer, and tighten. Screws should be torqued to 9in-lbs.

INSTALLING REMOVABLE POST SIGHT

The FastFire C includes an optional rear post sight. This feature is designed to be used in conjunction with the firearm's original front iron sight. You can install or remove the rear post sight using the same mounting screws used to mount the optic as seen in **Figure 2**.

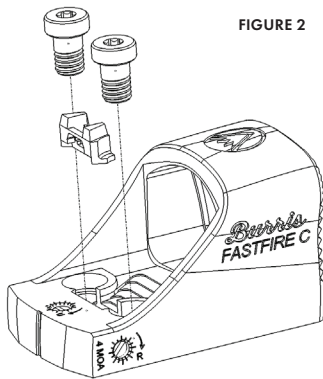

The FastFire C includes an optional **60 MOA shim** for increased elevation adjustment. The shim can be installed with the thick edge to the front for upward elevation adjustment or with the thick edge to the rear for additional downward elevation adjustment. Adding the optional shim can affect the screw thread depth.

60 MOA = 60in @ 100 yards
 30in @ 50 yards
 15in @ 25 yards.

FIGURE 3

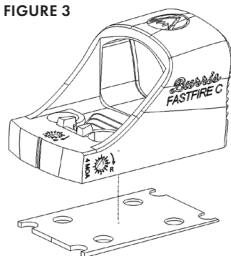

PISTOL MODELS	ACCESSORY FASTENER COMPATIBILITY	
	NO SHIM	WITH SHIM
SPRINGFIELD HELLCAT	M4x0.7 6.5mm	M4x0.7 7.0mm
SIG SAUER P365	M3x0.5 7.5mm	M3x0.5 7.5mm
S&W SHIELD PLUS	6-32 8.2mm	6-32 8.2mm
RUGER MAX 9	M4x0.7 7.0mm	M4x0.7 7.0mm
GLOCK 43/43X/48 MOS	M4x0.7 6.5mm	M4x0.7 7.0mm
CZ P-10 S	M4x0.7 7.0mm	M4x0.7 7.0mm
STOEGER STR-9	M4x0.7 6.5mm	M4x0.7 7.0mm
BERETTA 80X CHEETAH	M4x0.7 6.5mm	M4x0.7 7.0mm

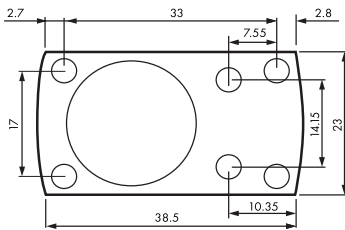

Shield RMSc™ Footprint
 Dimensions are in MM

OPERATING PROCEDURES

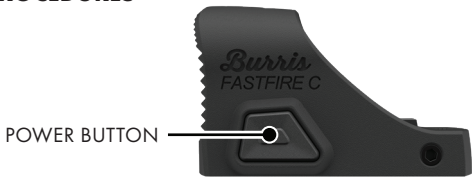

POWER MODES

The power button is located on the left side of the sight. For greater versatility to accommodate any light condition, there are five settings that can be used to adjust the brightness of the red dot along with an Auto setting. These include:

#1	High
#2	Medium High
#3	Medium
#4	Medium Low
#5	Low
Auto	Burris Intelligent Auto brightness.
Off	(Long Button Press)

BURRIS INTELLIGENT AUTO BRIGHTNESS CONTROL

When in "Auto", the sight will automatically adjust its brightness with the environment, changing its brightness smoothly. When the optic is holstered, concealed, or stored, the brightness goes into an extremely low consumption mode with a longer on time than the shelf life of the battery.

***After 5 hours all brightness settings default to auto. If a higher brightness than what is displayed is needed a single push will reset the dot to the highest brightness.

To turn the power off, simply press and hold the power button.

ELEVATION AND WINDAGE ADJUSTMENT

Adjusting Windage/Elevation can be made with the included tool or with a small flathead screwdriver. Each tick-mark on the sight body represents **4 MOA** of travel. There is **80 MOA** of Windage and Elevation adjustment.

ZEROING THE POINT-OF-IMPACT

Adjust the point-of-impact by using a small slot screwdriver. The direction of the shift of the point-of-impact is indicated on the elevation and windage adjustment screws. One tick mark on either adjustment screw corresponds to 4 minutes of angle (MOA), or approximately 4 inches at 100 yards or 1 inch at 25 yards.

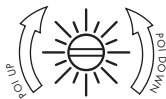

- Turning right moves point of impact Up
- Turning left moves point of impact Down

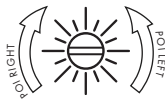

- Turning right moves point of impact Right
- Turning left moves point of impact Left

*Note: Point of Impact (POI) is where bullet hits target, not Red Aiming Dot

WARRANTY

The Fastfire C is covered by the
Burris Forever Warranty.[™]

Thank you for choosing Burris. You can be confident that the optic you purchased is built to the most exacting standards. You can count on Burris to perform every time you use it.

We're so confident in the craftsmanship of our products that we back them with a no questions asked Forever Warranty.

We will repair or replace your Burris optic if it is damaged or defective. The warranty is automatically transferred to future owners.

- No repair or replacement charge
- No warranty card needed
- No receipt required
- No questions asked



CARE AND MAINTENANCE

Remove dirt by blowing it off or using a soft lens brush. Use lens cleaning tissues on optical surfaces. The Fastfire C is water-resistant and will withstand rain or snow, however, after exposure to salty or dirty water, it is advisable to rinse with distilled water and dry the sight, as with any quality optical equipment.

HAVE YOU SEEN OUR MOBILE APP



BURRISCONNECT



DOWNLOAD

A ballistics powerhouse at your fingertips, the BurrisConnect app was built to be the solution for operating the Veracity PH, live media sharing on Burris Thermal, and the go-to ballistics tool for every shooter. BurrisConnect offers users the latest in bullet data to build DOPE cards, reticle maps, Eliminator data tables, and custom rifle profiles. From seasoned long-range competition enthusiasts to those just getting their first rifle zeroed. The ever-evolving, BurrisConnect app gives you everything you need to get dialed in.

- Control and program the Veracity PH
- Store Rifle profiles and ballistic data
- Adjust connected thermal device settings in real time via WI-FI
- Record video and capture images remotely with your thermal device.
- Build custom DOPE cards
- Reticle mapping for all Burris riflescopes
- Build Eliminator data tables

NOTE: The Fastfire C does not use functions on the app.





Burris Company
331 East 8th St., Greeley, CO 80631
(970) 356-1670
BurrisOptics.com
Facebook.com/BurrisOptics
INSTR-9239